

🕒 **5.15 PM**  
CHAT WITH COLLEAGUES

🕒 **6.30 PM**  
FAMILY TIME WITH IVAN

**SUNO**

**BECAUSE YOU HAVE  
SO MUCH LIFE TO LIVE**

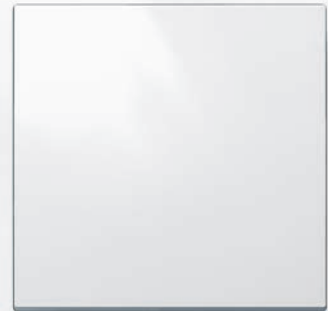

THE **GLOBAL SPECIALIST**  
IN ELECTRICAL AND DIGITAL BUILDING INFRASTRUCTURES

 **legrand**<sup>®</sup>

# A STYLE THAT FEELS LIKE YOU

Because living in an interior that feels like us is the most important thing when it comes to feeling good. Because there are often things to be installed that don't go with everything else, we have created **SUNO**.

Simple, timeless and neutral, it blends in seamlessly with your interior.

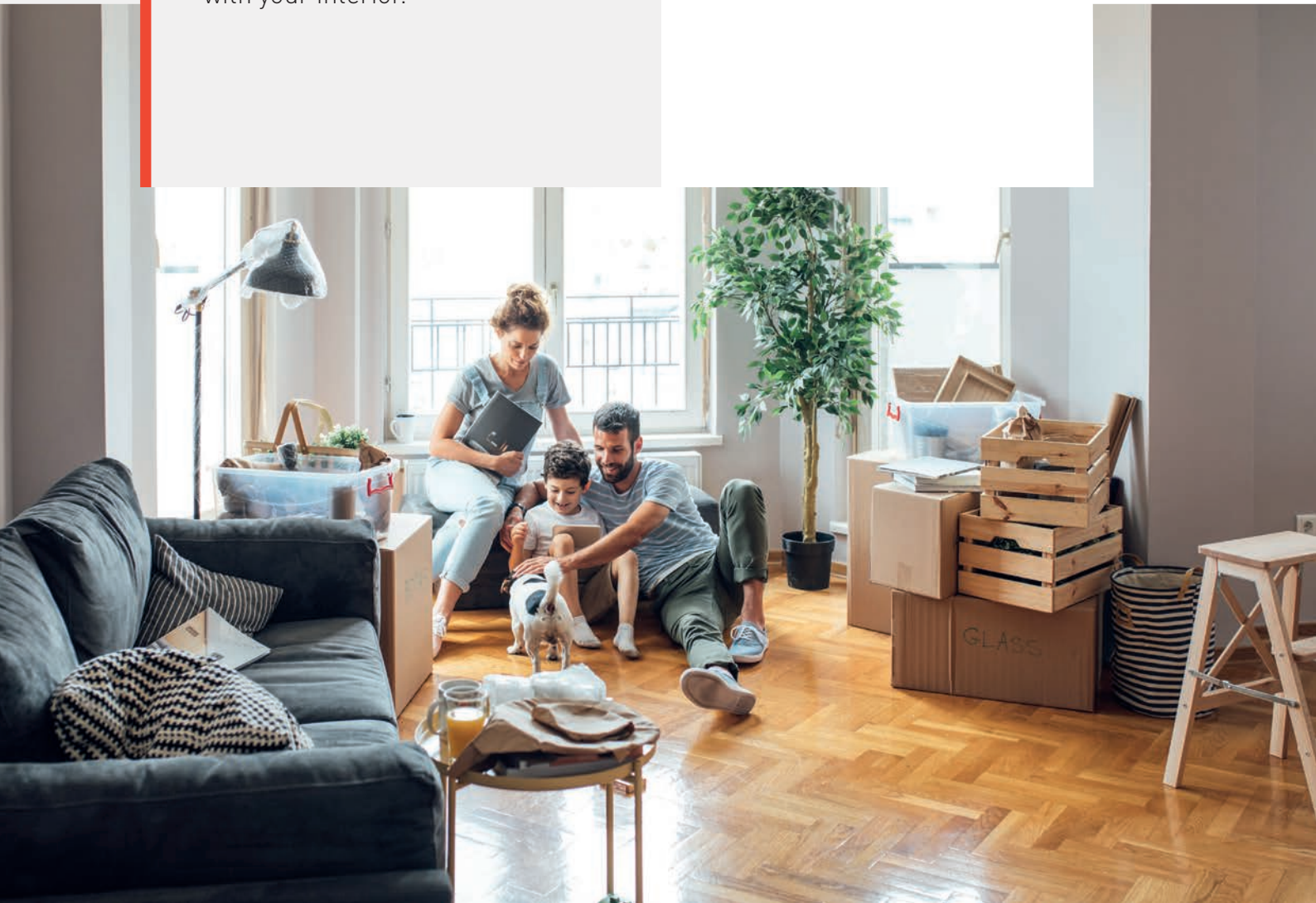

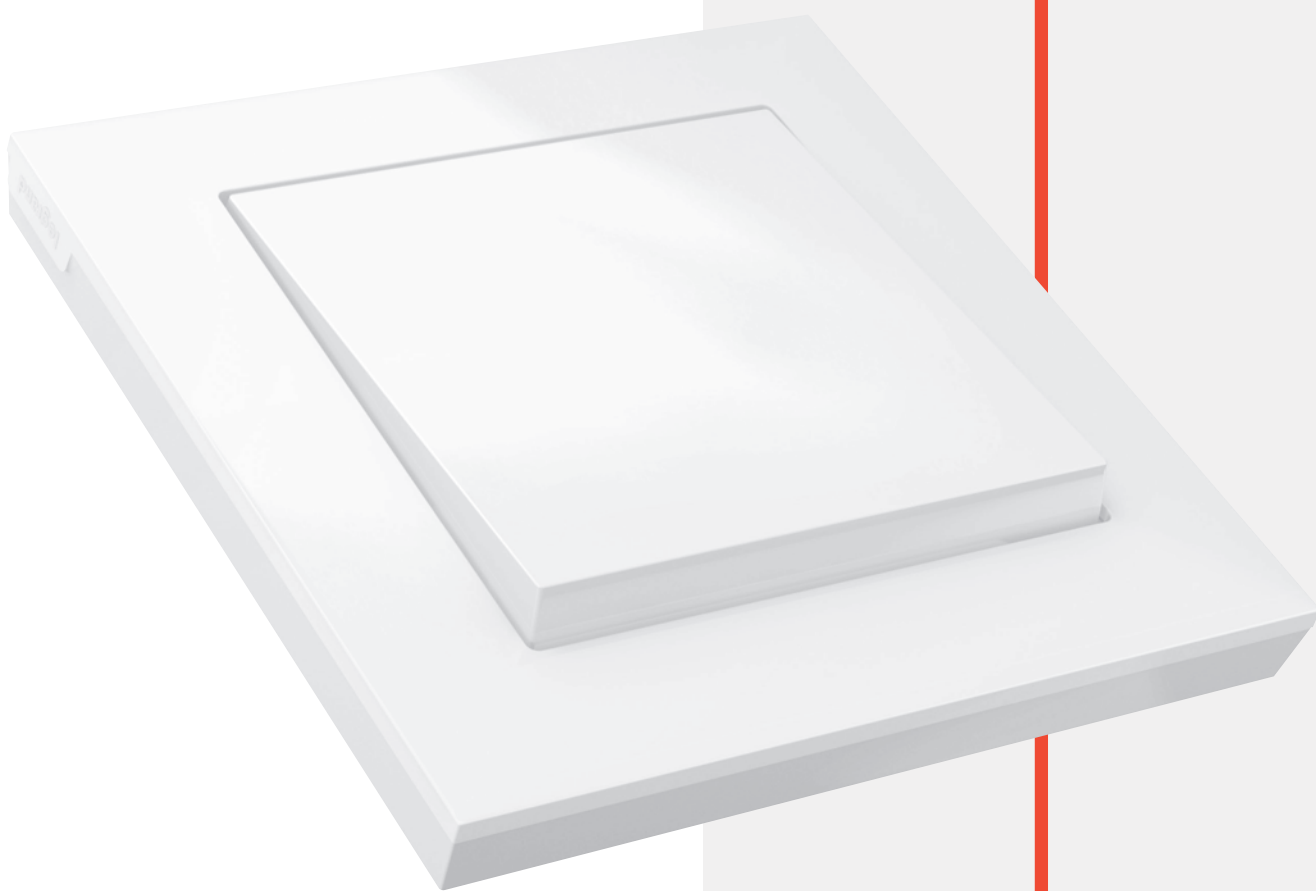

Sharp corners and a slight curvature on the top are discreet features.

**Suno, personality with a subtle touch.**

**ONE ROOM, ONE ENVIRONMENT!  
YOUR DESIRES, YOUR COLOURS!**

# HARMONISE YOUR COLOURS

3 total look finishes for integration in complete discretion  
whatever your style.

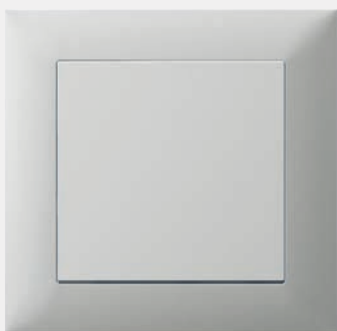

**Aluminum**



**Matt Black**



**White**

5 additional plates for a multitude of combinations and above all, for more character.

**Textured, polished or matt, letting you choose exactly the combination that suits you**

#### TEXTURED

---



**Brushed Aluminium**

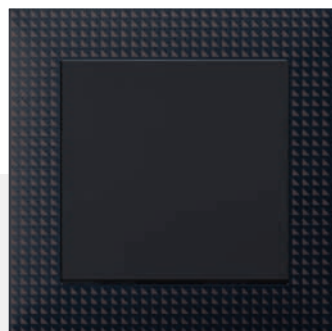

**Patterned Black**

#### MATT

---



**Dark Grey**

#### POLISHED

---



**Feather**



**Dune**

# EASY AND INTUITIVE

- ✓ 100% compatibility with all wall boxes thanks to the reduced height and depth of the mechanism
- ✓ Quick wiring with automatic terminals
- ✓ Always safe: no finger contact with live parts thanks to the IP20 protected contacts

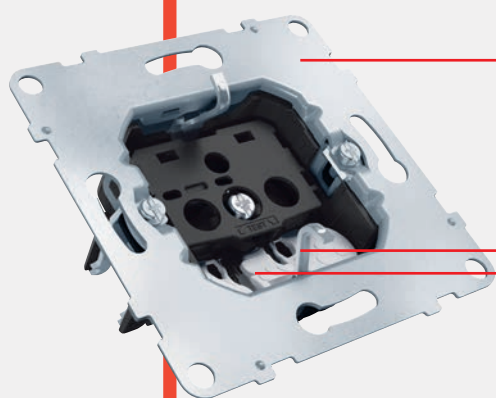

Rigid metal support frame

Test points for checking connections

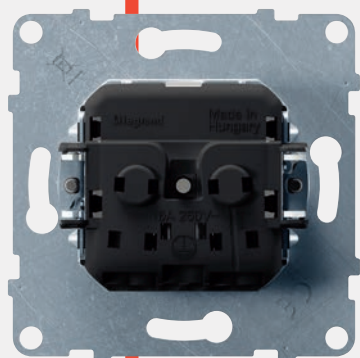
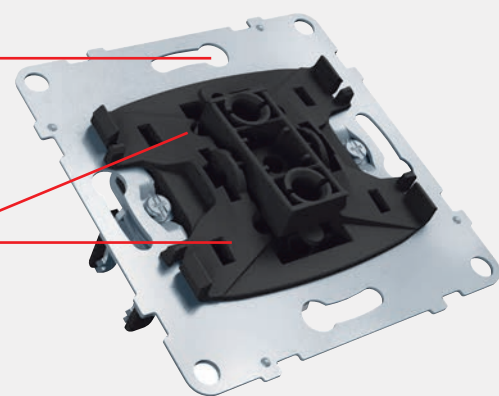

Wiring diagram marked on the back of the controls

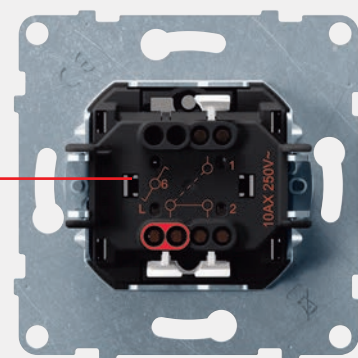

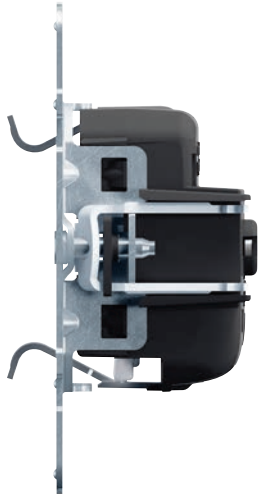

Protected claws, to prevent cable insulation damage

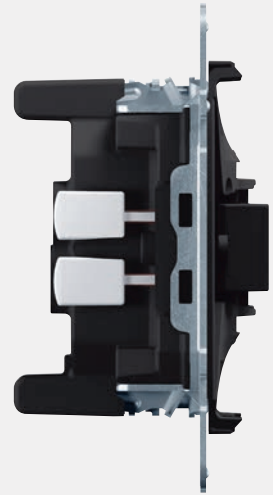

🕒 **5 PM**  
APPOINTMENT WITH  
MRS SMITH TO INSTALL  
A SUNO PRODUCT

🕒 **5.30 PM**  
A WALK IN THE FOREST...  
WITH THE FAMILY TOO!

# ENJOY FRE

## Installing sockets

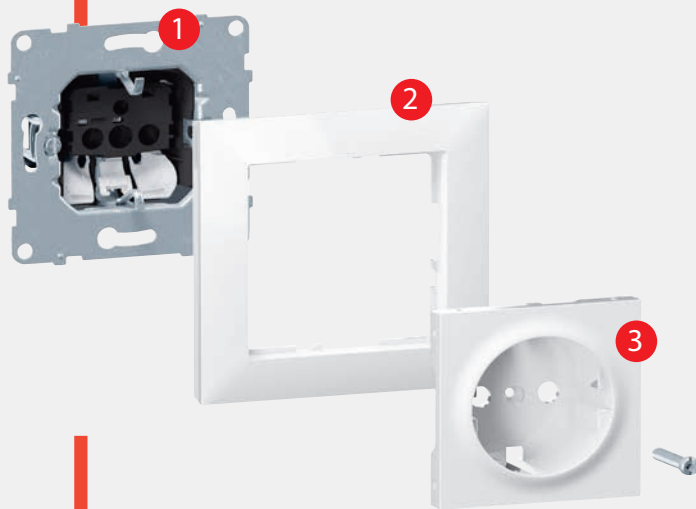

**Flexible installation system,  
for a perfect fit in every situation**

- 1 Fix the support frame in the box using screws or claws
- 2 Place the plate on the mechanism
- 3 Tighten the plate on the wall by screwing in the cover plate.

## Installing switches

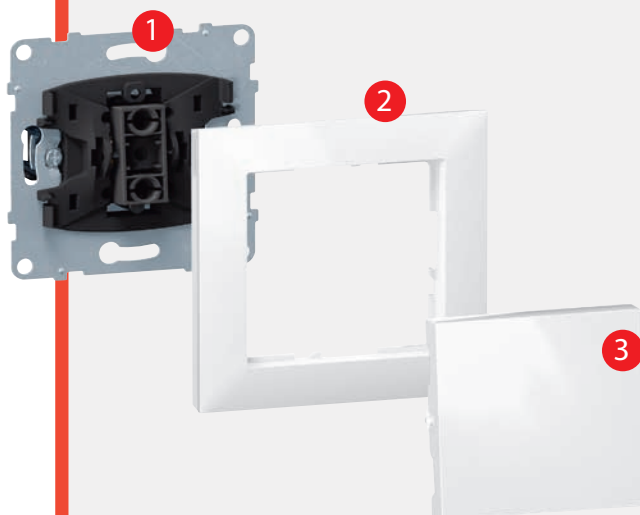

**Perfect alignment of the rocker  
and the plate, no “letterbox” effect**

- 1 Fix the support frame in the box using screws or claws
- 2 Pre-clip the plate on the mechanism
- 3 Finish the installation by clipping the rocker into place



# EDOM OF CHOICE

## Multi-gang

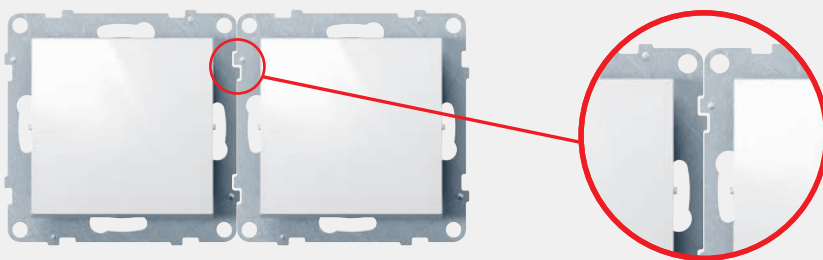
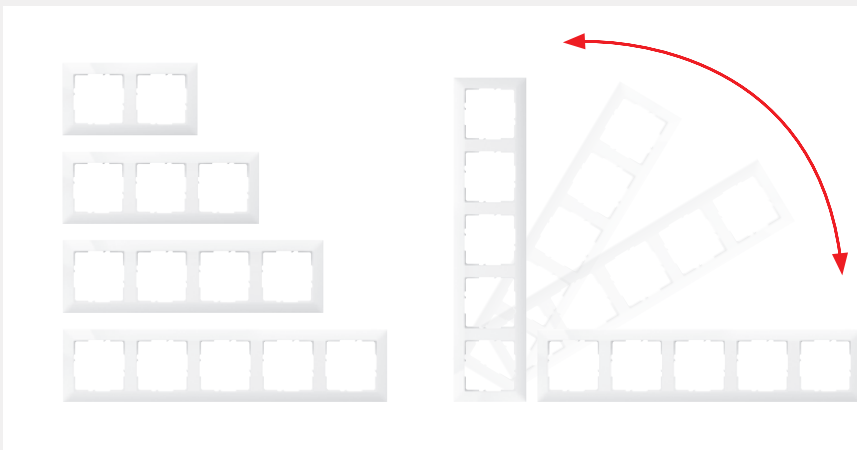

# NEVER SHORT OF ENERGY

Do you have boundless energy? **SUNO does too!**

Do you play the electric guitar, video games, music? Suno provides a power source for each of your passions!



2P+E shuttered socket



2P



2P+E socket with  
safety flap



2P+E double socket

🕒 9 AM  
WORKING ON MY  
LATEST PROJECT

🕒 9 PM  
LISTEN TO MUSIC  
AFTER WORK



USB Type-A +  
Type-C charger socket



2P+E + USB  
Type-C socket



Wireless wall charger +  
USB Type-A socket

# MORE CONT

Enhanced functionality, improved convenience.  
A whole spectrum of controls accommodates any requirement.

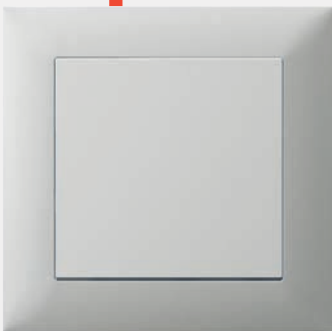

1-gang switch

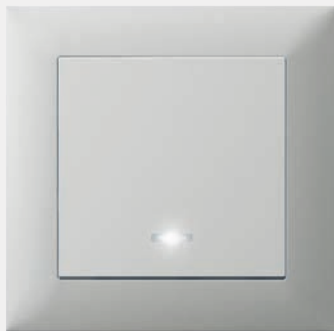

Illuminated or  
indicator switch



3-gang switch



Pull-cord switch

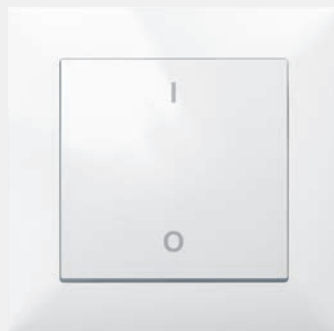

Double pole switch



2-gang switch

# ROLS



🕒 **9 PM**  
SUBDUED ATMOSPHERE  
IN MY LIVING ROOM



🕒 **10 AM**  
CALL WITH THE TEAM

# THE PERFECT ENVIRONMENT COMBINED WITH ENERGY SAVING IS

# NOW

Saving energy and the costs that come with it is possible. Control your lighting system efficiently with universal dimmers and automatic switches.

From very dim via to moon-glow through to full brightness, adjust your lighting precisely to your desired setting.



Push dimmer



Rotary dimmer

**Only have lights on where they're needed.**



3-wire automatic switch



2-wire automatic switch

# POSSIBLE



Thermostat



Switch



Roller shutter control

# DATA, TV AND AUDIO/VIDEO CONNECTIONS

A complete range of products dedicated to audio/video connections provides the desired level of entertainment, relaxation and functionality.



TV socket



TV-R-SAT-SAT socket



HDMI



RJ45 CAT6 UTP +  
TYPE-F TV





RJ11+RJ45 CAT6 UTP



RJ45 CAT5e UTP

# WATERPROOF DEVICES

No doubt about it, Suno is your range for all seasons!



IP44 automatic switch



IP44 2P+E socket

## IP44 Range

Suno IP44 products are the ideal solution for damp rooms, such as bathrooms, kitchens, utility rooms, or even sheltered outdoor areas.



IP44 universal plate



IP44 kit for  
1-gang switch

The IP44 kit allows you to waterproof standard mechanical controls.



IP44 kit for  
2-gang switch

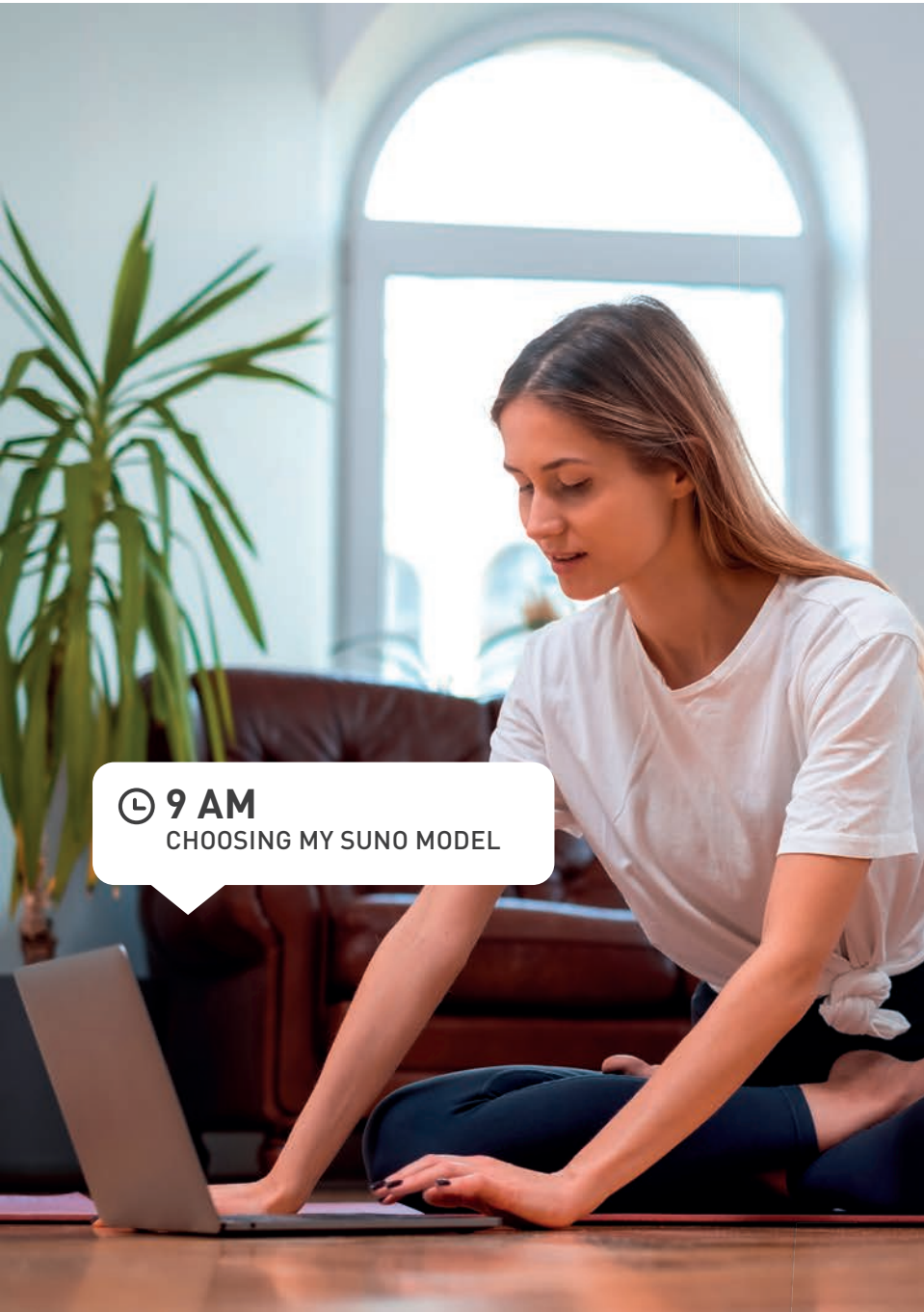

🕒 9 AM  
CHOOSING MY SUNO MODEL



🕒 9.30 AM  
STARTING MY YOGA CLASS

# A CONNECTED HOME

**AT YOUR FINGERTIPS...  
AND WITHIN YOUR BUDGET!**

With **SUNO with Netatmo**, it's quick and easy to get a connected home! Imagine that your home responds to your touch and your voice, you can control it remotely and it helps you save energy!

## **Easy to install**

Discreetly installed, your connected switches and outlets replace your existing equipment, quickly and without mess. You can start with just one room or connect your entire home all at once. Or start with just your lights or your roller shutters. In any case, you can easily expand your system by gradually adding more connected products, depending on your desires and budget. And each new device will integrate easily into your system for an ever more comfortable and secure home.

## Always on duty

With the scheduling function, you can set your home to close down every night at a specific time, which can be later at the weekend. When you're away, your connected home simulates your presence, shows you what's happening and alerts you immediately on your smartphone if something unexpected occurs.

## Easy to control

Arms full, in the shower, in the yard or on the other side of the world... Anytime, anywhere, keep control of your home with a tap or a word. And when you aren't there, keep an eye on your house at all times. If ever there's a problem, such as a power failure or excessive consumption, your smartphone alerts you.

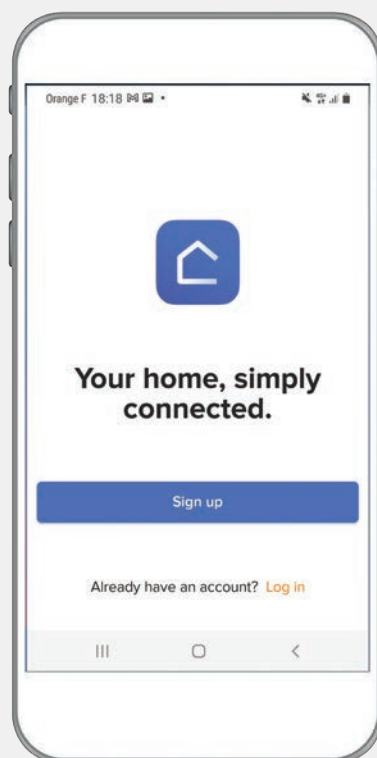

SIMPLE AND EASY TO USE:  
A CONNECTED HOME

# FOR THE WHOLE FAMILY



**Talk**

Even more simply, control your home using your voice with Google Assistant, Alexa or Siri.



Works with  
**Apple HomeKit**



works with the  
**Google Assistant**



WORKS WITH  
**alexa**

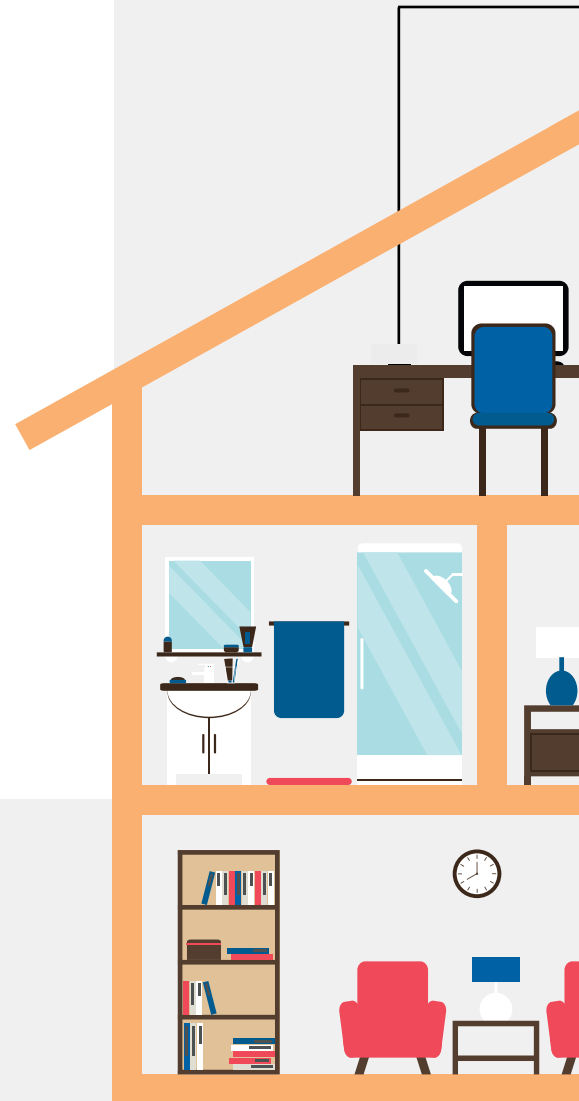

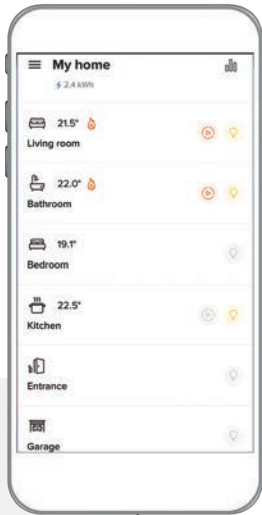

## Swipe

Home + Control app:  
Wherever you are, control your home using your fingertips on your tablet or smartphone.

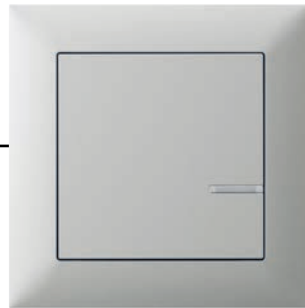

## Touch

Connected switches, wired or wireless,  
always ready for your touch.

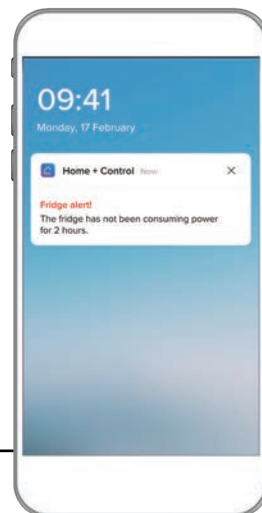

## Alert

Be alerted to unexpected events:  
malfunction, excessive consumption, power cut, etc.

**MAKE SAVINGS...**

# AND ENJOY LIFE!

## **Invest a little**

A connected home has never been so accessible.

The starter pack and each additional product or pack can be purchased separately and integrated easily. Netatmo works with the largest brands – such as Apple HomeKit, Google Home, Amazon Echo, Somfy, Netatmo, Bubendorff – enabling you to add third-party products to your system to enrich its functionality even further.

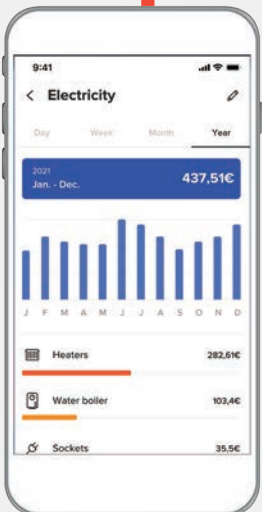

## **Save a lot**

Improve your comfort, even while saving energy.

The Home + Control app allows you to view your consumption in great detail: at that particular moment or over a period of time; for a specific light or appliance, or for all of them together. That detail can help you optimize your energy savings.

## **Save time... and gain peace of mind!**

Configure your controls, your security system and your alerts, and let the house do the rest! No more need to think of everything, Suno does it for you. On a daily basis, you'll save a significant amount of time, and experience unparalleled peace of mind!



## I CAN PERSONALISE MY LIGHTS

**Cosy, bright or colourful - change the atmosphere according to your mood.**

Simply click on the app or use your voice to adjust the lights and they will obey you instantly!

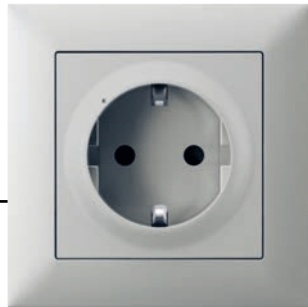
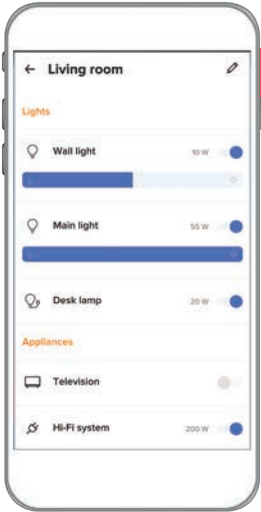

In-wall connected power outlet

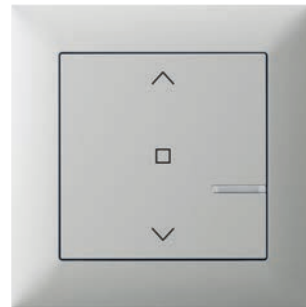

Connected shutter switch with neutral

**ALEXA,**  
SWITCH ON MY  
DESK LAMP

**OK GOOGLE**  
SWITCH OFF THE  
LIVING ROOM LIGHT!



Works with  
**Apple HomeKit**

works with the  
**Google Assistant**

WORKS WITH  
**alexa**

2-way on/off remote  
wireless switch

**legrand**

## I'M DEALING WITH THE BABY

**It's bedtime.** I choose "baby night time" on my scenario control. The shutters close, the mobile starts turning and the night light comes on simultaneously. Baby can go to sleep in peace.

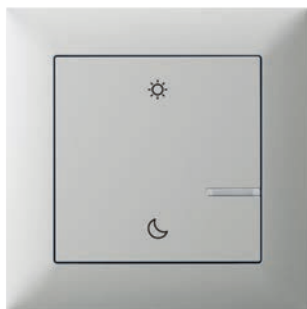
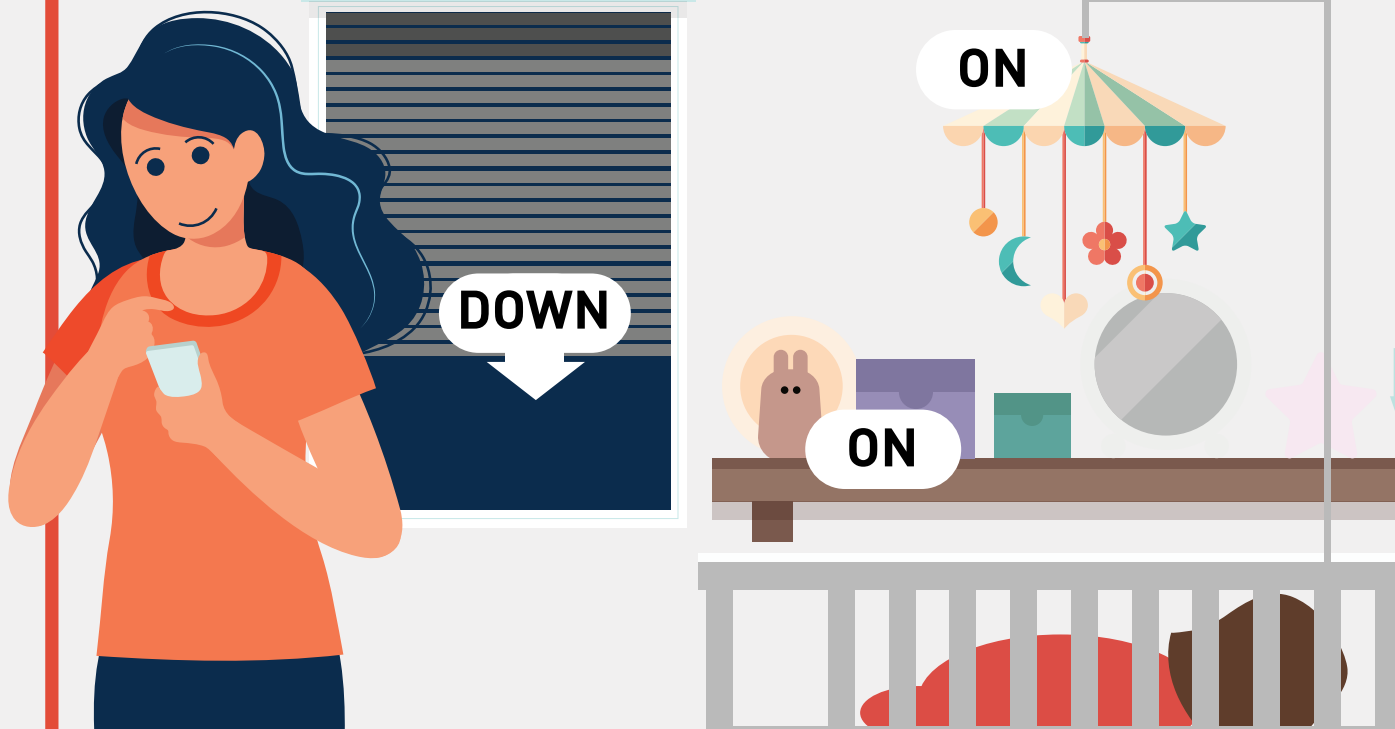

Wake up/Sleep remote wireless switch



In-wall connected power outlet

Switch to "baby night time" mode with just one touch. Simply press the atmosphere you have configured. Now you can concentrate on the most important thing - looking after your baby.

Baby wakes up in the middle of the night. I can turn on the night light, the mobile and soothing music with one click on my remote control.

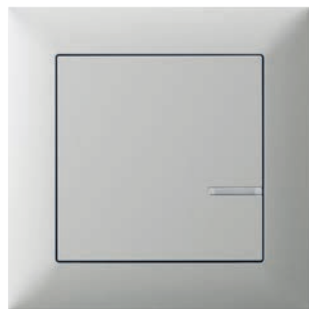

**5-300 W  
connected dimmer switch  
without neutral**

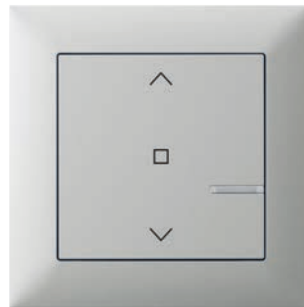

**Connected shutter  
switch with neutral**

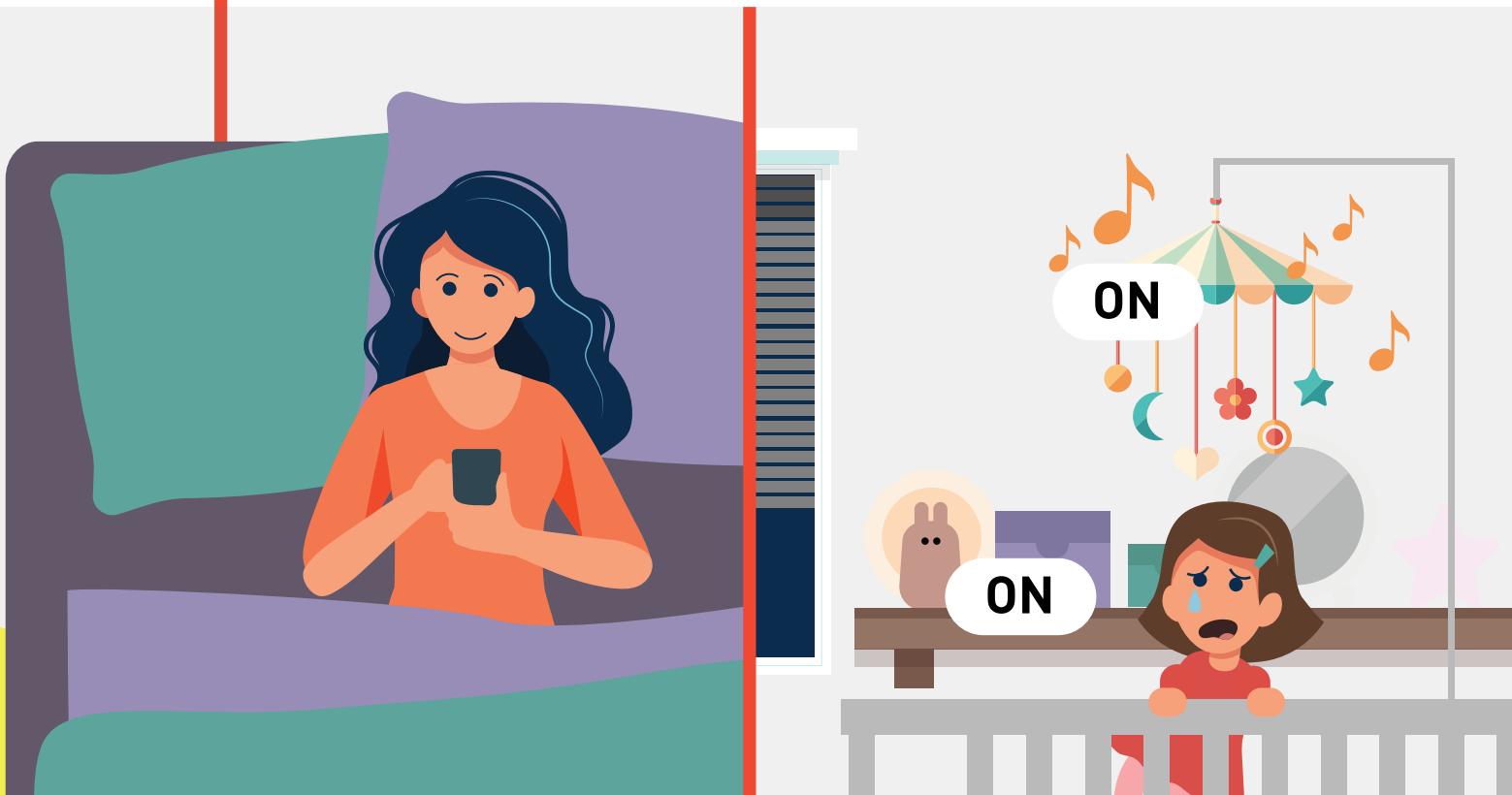

## LEAVING THE HOUSE/ARRIVING BACK HOME

### Never forget to switch anything off!

With centralised roller shutters, I can open and close the whole house at the same time with a single control! Better still: nobody's left at home, and in the blink of an eye I can press LEAVE mode: the lights go out, the shutters are lowered, etc. And the house obediently waits for us to come home!

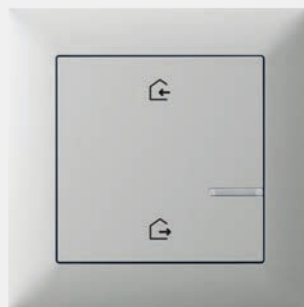

Home/Away  
wireless remote  
master switch

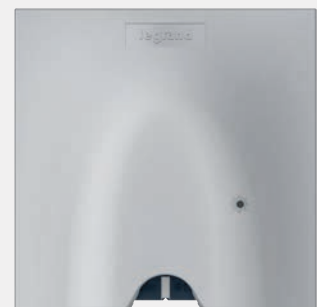

16 A connected  
cable outlet

## I'M NOT AT HOME

### A securely guarded home!

In addition to Leave mode, with a few clicks on your app, you can configure "smart notifications" that flag up the slightest change in your home when you're not there! A light left on, a shutter not closed? You are immediately alerted.

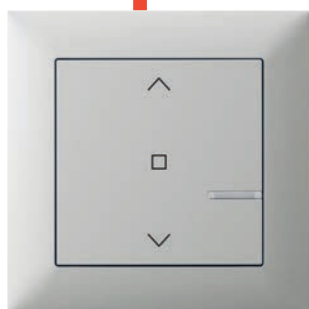
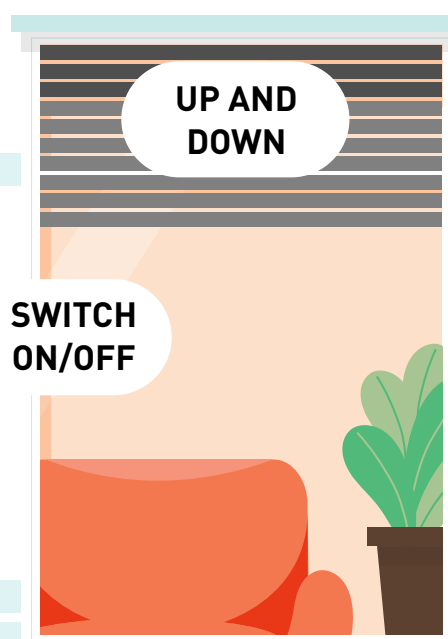
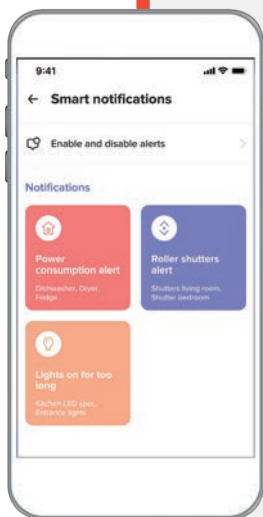

Roller shutter wireless remote master switch



# I CAN CONTROL MY ENVIRONMENTS IN COMPLETE SAFETY

## Everyone has their own space and their own environment!

On a single switch, I can control the brightness of the lights in 3 different places: subdued lighting for reading by the fireside, brighter in the kitchen and especially bright in the corner where Granny is knitting!

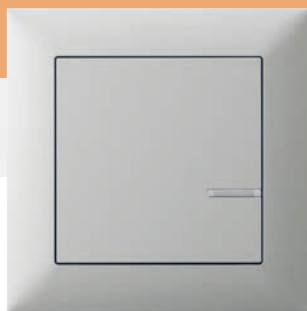

5-300 W  
connected dimmer switch  
without neutral



150 W  
connected dimmer switch  
with neutral



4-button  
wireless remote  
scenario switch

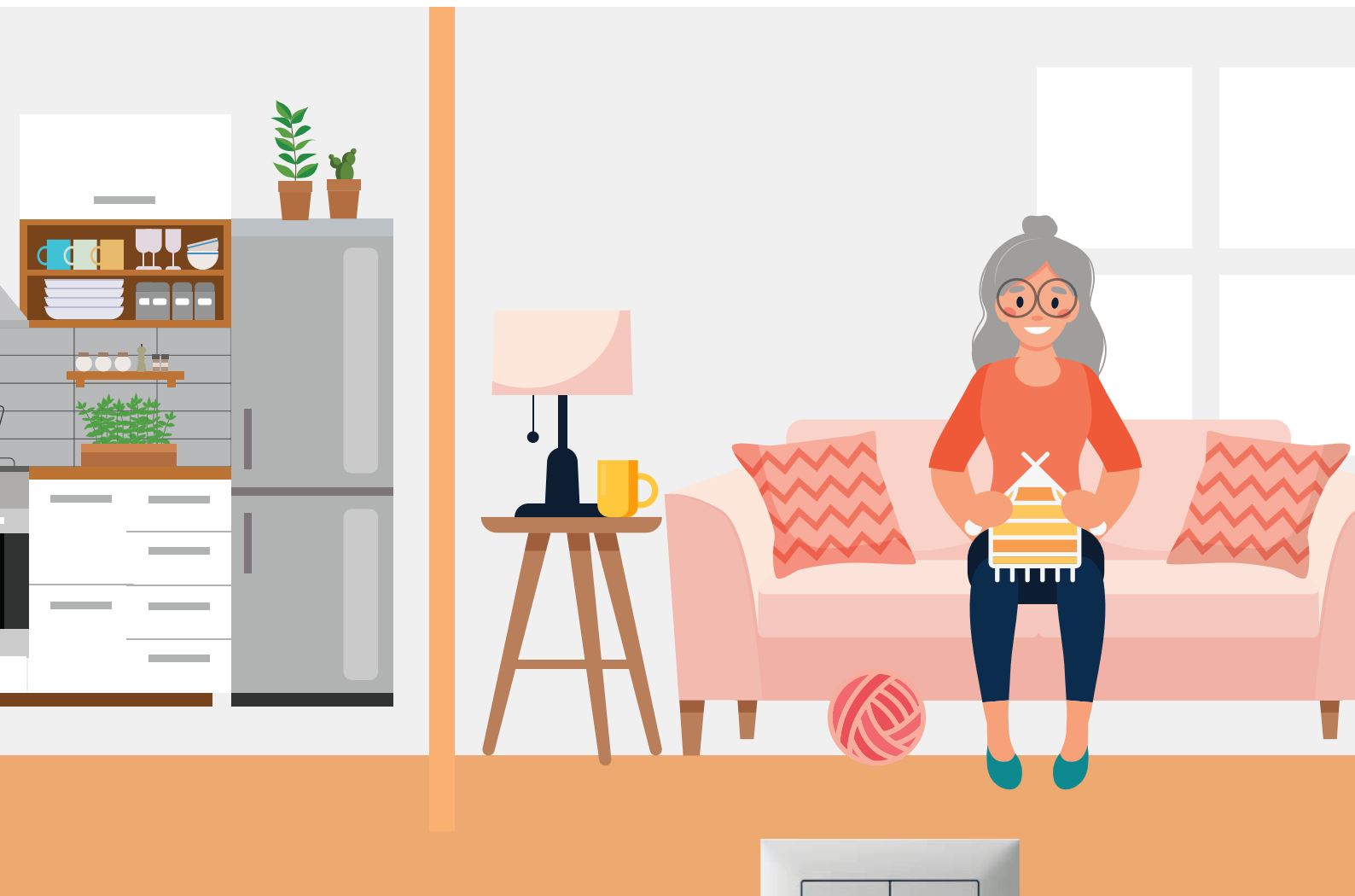

2x250 W 2-gang  
connected light  
switch with neutral

CONTROL YOUR CONNECTED HOME WITH

# YOUR APPS

Simply ask, and your home grants your wishes.



## Monitor consumption

Take complete control of your energy consumption.



## Monitor comfort

Adapt your heating to your daily routine.



## Control openings

Open and close your shutters easily.





## Welcome

Greet your visitors even when away from home.

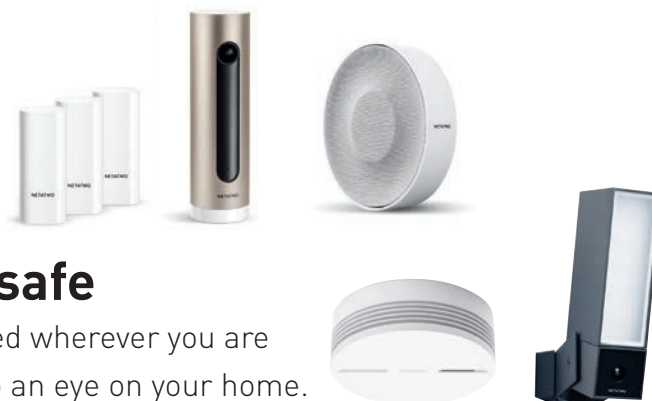

## Feel safe

Be alerted wherever you are and keep an eye on your home.



-  Home + Control
-  Home + Security

## Master your environment

Understand and control your environment.



## Control your lighting

Update your lighting to a connected version.





7 211 06 + 7 215 01



7 213 08 + 7 215 11



7 212 03 + 7 215 81



7 210 40

Supplied with cover plates and metal support frames  
 To be equipped with plates  
 Fixing with claws (supplied) or screws  
 After clipping in the rocker, all LED lamps light up white  
 Flow pack packaging: robust protection to ensure optimum operation

Pack	Cat.Nos	Switches 10 AX - 250 V~
10	7 211 01	<b>One-way switch</b> Automatic terminals ○ White ● Ivory ● Aluminium ● Black
10	7 212 01	
10	7 213 01	
10	7 214 01	
5	7 211 11	<b>Illuminated/indicator one-way switch</b> Automatic terminals Equipped with 0.125 mA low consumption LED (Cat.No. 7 645 26) ○ White ● Ivory ● Aluminium ● Black
5	7 212 11	
5	7 213 11	
5	7 214 11	
10	7 211 06	<b>Two-way switch</b> Automatic terminals ○ White ● Ivory ● Aluminium ● Black
10	7 212 06	
10	7 213 06	
10	7 214 06	
5	7 211 16	<b>Illuminated/indicator two-way switch</b> Automatic terminals Equipped with 0.125 mA low consumption LED (Cat.No. 7 645 26) ○ White ● Ivory ● Aluminium ● Black
5	7 212 16	
5	7 213 16	
5	7 214 16	
5	7 211 07	<b>Intermediate switch</b> Screw terminals ○ White ● Ivory ● Aluminium ● Black
5	7 212 07	
5	7 213 07	
5	7 214 07	
5	7 211 02	<b>Double pole switch</b> Screw terminals ○ White ● Ivory ● Aluminium ● Black
5	7 213 02	
5	7 214 02	
5	7 214 02	
5	7 211 12	<b>Indicator double pole switch</b> Screw terminals Equipped with 3 mA low consumption LED (Cat.No. 6 650 91) ○ White ● Ivory ● Aluminium ● Black
5	7 213 12	
5	7 214 12	
10	7 211 05	<b>2-gang one-way switch</b> Automatic terminals ○ White ● Ivory ● Aluminium ● Black
10	7 212 05	
10	7 213 05	
10	7 214 05	
5	7 211 15	<b>Illuminated/indicator 2-gang one-way switch</b> Automatic terminals Equipped with 2 x 0.125 mA low consumption LED (Cat.No. 7 645 26) ○ White ● Ivory ● Aluminium ● Black
5	7 212 15	
5	7 213 15	
5	7 214 15	

Pack	Cat.Nos	Switches 10 AX - 250 V~ (continued)
5	7 211 08	<b>2-gang two-way switch</b> Automatic terminals ○ White ● Ivory ● Aluminium ● Black
5	7 212 08	
5	7 213 08	
5	7 214 08	
5	7 211 18	<b>Illuminated/indicator 2-gang two-way switch</b> Automatic terminals Equipped with 2 x 0.125 mA low consumption LED (Cat.No. 7 645 26) ○ White ● Ivory ● Aluminium ● Black
5	7 212 18	
5	7 213 18	
5	7 214 18	
5	7 211 04	<b>Switches 16 AX - 250 V~</b> <b>One-way switch</b> Automatic terminals ○ White ● Ivory ● Aluminium ● Black
5	7 212 04	
5	7 213 04	
5	7 214 04	
5	7 211 14	<b>Indicator one-way switch</b> Automatic terminals Equipped with 2.5 mA low consumption LED (Cat.No. 7 645 21) ○ White ● Ivory ● Aluminium ● Black
5	7 213 14	
5	7 214 14	
5	7 211 03	<b>Switch 20 AX - 250 V~</b> <b>3-gang one-way switch</b> Screw terminals ○ White ● Ivory ● Aluminium ● Black
5	7 212 03	
5	7 213 03	
5	7 214 03	
10	7 210 40	<b>IP 44 kits</b> Accessory kits to create IP 44 switches/push-buttons The kits transform IP2X switches to IP 44 IP 44 accessory for single switches <sup>(1)</sup>
5	7 210 41	

1: Except for double pole switches, intermediate switch, 3-gang one-way switch

# Suno™

## push-buttons with cover plate



7 211 00 + 7 215 01

Supplied with cover plates and metal support frames  
To be equipped with plates  
Fixing with claws (supplied) or screws  
After clipping in the rocker, all LED lamps light up white  
Flow pack packaging: robust protection to ensure optimum operation

Pack	Cat.Nos	Push-buttons 6 A - 250 V~
		Automatic terminals
		<b>One-way push-button</b>
		Automatic terminals
10	7 211 09	<ul style="list-style-type: none"> <li>○ White</li> <li>● Ivory</li> <li>● Aluminium</li> <li>● Black</li> </ul>
10	7 212 09	
10	7 213 09	
10	7 214 09	
		<b>Illuminated one-way push-button with label-holder</b>
		Automatic terminals
		Equipped with 0.125 mA low consumption LED (Cat.No. 7 645 26)
		With transparent rocker (label-holder).
		3 different coloured inserts (white/ivory, aluminium, black)
5	7 211 10	<ul style="list-style-type: none"> <li>○ White/Ivory</li> <li>● Aluminium</li> <li>● Black</li> </ul>
5	7 213 10	
5	7 214 10	
		<b>One-way push-button with bell symbol</b>
		Automatic terminals
5	7 211 13	<ul style="list-style-type: none"> <li>○ White</li> <li>● Aluminium</li> <li>● Black</li> </ul>
5	7 213 13	
5	7 214 13	
		<b>2-gang one-way push-button</b>
		Automatic terminals
5	7 211 17	<ul style="list-style-type: none"> <li>○ White</li> <li>● Ivory</li> <li>● Aluminium</li> <li>● Black</li> </ul>
5	7 212 17	
5	7 213 17	
5	7 214 17	
		<b>Pull-cord changeover push-button</b>
		Automatic terminals
1	7 211 00	<ul style="list-style-type: none"> <li>○ White</li> <li>● Aluminium</li> <li>● Black</li> </ul>
1	7 213 00	
1	7 214 00	

# Suno™

## dimmers



7 213 79 + 7 215 11



7 214 78 + 7 215 21

Supplied with cover plates and metal support frames  
To be equipped with plates  
Fixing with claws (supplied) or screws  
Flow pack packaging: robust protection to ensure optimum operation

Pack	Cat.Nos	Dimmers 240 V~ - 50 Hz
		Equipped with overvoltage and short-circuit protection
		When switched on, light up at the level set before last switch-off
		Screw terminals
		Can be remotely controlled via non-illuminated push-buttons (Cat.No. 7 211 09), with each push-button able to perform the ON/OFF and dimming function
		<b>Rotary dimmer without neutral</b>
		For all types of lamps:
		- dimmable LEDs: 5 W to 75 W (10 lamps max.)
		- dimmable compact fluorescent lamps: 5 W to 75 W (10 lamps max.)
		- halogen with ferromagnetic or electronic transformer: 5 VA to 300 VA
		- fluorescent tube - ballast: 5 VA to 300 VA
		- halogen and incandescent 240 V~: 5 W to 300 W
		When switched on, gradually (2 seconds) lights up at the level set before last switch-off
1	7 211 79	<ul style="list-style-type: none"> <li>○ White</li> <li>● Ivory</li> <li>● Aluminium</li> <li>● Black</li> </ul>
1	7 212 79	
1	7 213 79	
1	7 214 79	
		<b>Push-dimmer without neutral</b>
		For all types of lamp:
		- dimmable LEDs: 5 W to 75 W (10 lamps max.)
		- dimmable compact fluorescent lamps: 5 W to 75 W (10 lamps max.)
		- halogen with ferromagnetic or electronic transformer: 3 VA to 400 VA
		- fluorescent tube - ballast: 3 VA to 200 VA
		- halogen and incandescent 240 V~: 3 W to 400 W
		When switched on, gradually (2 seconds) lights up at the level set before last switch-off
		Functioning:
		- dimming mode
		- pre-set level mode (0%, 33%, 66%, 100%)
		- night-light mode: dimming down of the lamp for 1 hour
1	7 211 78	<ul style="list-style-type: none"> <li>○ White</li> <li>● Ivory</li> <li>● Aluminium</li> <li>● Black</li> </ul>
1	7 212 78	
1	7 213 78	
1	7 214 78	



7 212 76 + 7 215 81

7 211 35 + 7 215 01

7 214 77 + 7 215 21

Supplied with cover plates and metal support frames  
To be equipped with plates  
Fixing with claws (supplied) or screws  
Flow pack packaging: robust protection to ensure optimum operation

Pack	Cat.Nos	Motion sensors
		All sensors are compatible with any type of lamp Detection field 120° Detection range 8 m Integrated self-protection against overloads and short-circuits Time delay adjustable from 10 s to 10 min Light level threshold adjustable from 5 to 1275 lux Screw terminals <b>Motion sensor without neutral - with settings</b> Used to control: - 3 to 100 W LED and compact fluorescent lamps - 3 to 250 VA LED, CFL, halogen and fluorescent tubes with ferromagnetic or electronic ballast - 3 to 250 W halogen (230 V~) and incandescent lamps If several sensors are installed on the same circuit, the minimum load changes: refer to the technical data sheet Up to 3 sensors can be installed in parallel Standby consumption: 0.02 W ○ White ● Ivory ● Aluminium ● Black
1	7 211 76	
1	7 212 76	
1	7 213 76	
1	7 214 76	
		<b>Motion sensor without neutral - IP 44</b> Used to control: - 3 to 100 W LED and compact fluorescent lamps - 3 to 250 VA LED, CFL, halogen and fluorescent tubes with ferromagnetic or electronic ballast - 3 to 250 W halogen (230 V~) and incandescent lamps If several sensors are installed on the same circuit, the minimum load changes: refer to the technical sheet Up to 3 sensors can be installed in parallel Standby consumption: 0.02 W ○ White ● Ivory ● Aluminium ● Black
1	7 211 35	
1	7 213 35	
1	7 214 35	
		<b>Motion sensor with neutral</b> Used to control: - 0 to 50 W LED and compact fluorescent lamps - 0 to 200 VA LED, CFL and halogen with ferromagnetic or electronic ballast - 0 to 150 VA fluorescent tubes with ferromagnetic or electronic ballast - 0 to 400 W halogen (230 V~) and incandescent lamps No remote manual control with push-button Standby consumption: 0.55 W ○ White ● Ivory ● Aluminium ● Black
1	7 211 77	
1	7 212 77	
1	7 213 77	
1	7 214 77	



7 213 38 + 7 215 11

7 211 36 + 7 215 01

7 214 75 + 7 215 21

Supplied with cover plates and metal support frames  
To be equipped with plates  
Fixing with claws (supplied) or screws  
Flow pack packaging: robust protection to ensure optimum operation

Pack	Cat.Nos	Roller shutter controls
		Automatic terminals <b>Roller shutter switch 6 AX - 250 V~</b> 3 positions: up, down, stop Direct control of the motor ○ White ● Ivory ● Aluminium ● Black
5	7 211 39	
5	7 212 39	
5	7 213 39	
5	7 214 39	
		<b>Roller shutter push-button 6 A - 250 V~</b> 3 positions: up, down, stop ○ White ● Ivory ● Aluminium ● Black
5	7 211 38	
5	7 212 38	
5	7 213 38	
5	7 214 38	
		<b>Thermostats</b> <b>Electronic room thermostat</b> Control knob with index and adjustable segments for min. and max. settings Adjustable range from 5°C to 30°C (+/- 0.5°C) Power supply: 230 V~ - 50/60 Hz One volt-free changeover contact output Suitable for controlling heated ceilings and underfloor heating - LV use breaking capacity: 8 A - 250 VA - resistive inductive circuit 2 A - 250 VA - inductive circuit - ELV use breaking capacity: 12 to 48 V~ - 12 to 24 V=, from 1 mA min. to 500 mA max. Screw terminals ○ White ● Ivory ● Aluminium ● Black
1	7 211 36	
1	7 212 36	
1	7 213 36	
1	7 214 36	
		<b>Floor heating thermostat</b> With One volt-free N/O contact and LED 16 A - 230 VA Adjustable range from 10°C to 60°C Supplied with 4 m floor sensor (max. sensor length: 20 m) Automatic frost protection below 7°C Screw terminals ○ White ● Ivory ● Aluminium ● Black
1	7 211 37	
1	7 212 37	
1	7 213 37	
1	7 214 37	
		<b>Ventilation control switch (0, 1, 2, 3)</b> AC 23 A 2.5 kW, AC 21 A 20 A Screw terminals ○ White ● Ivory ● Aluminium ● Black
1	7 211 40	
1	7 212 40	
1	7 213 40	
1	7 214 40	
		<b>Mechanical keycard switch</b> For energising a circuit by inserting a card Example of use: hotel room power supply only when the guest is present To be used with card Cat.No. 0 898 06 (not supplied) Mechanism without time delay after card removal Automatic terminals ○ White ● Ivory ● Aluminium ● Black
3	7 211 75	
3	7 212 75	
3	7 213 75	
3	7 214 75	

# Suno™

## socket outlets



7 211 20 + 7 215 01



7 213 23 + 7 215 11



7 211 26

Supplied with cover plates and metal support frames  
 To be equipped with plates  
 Fixing with claws (supplied) or screws  
 Flow pack packaging: robust protection to ensure optimum operation

Pack	Cat.Nos	2P socket outlets 16 A - 250 V~	Pack	Cat.Nos	German standard socket outlets 16 A - 250 V~ (continued)
10	7 211 33	<b>2P socket - screw terminals</b> <ul style="list-style-type: none"> <li>○ White</li> <li>● Ivory</li> <li>● Aluminium</li> <li>● Black</li> </ul>			<b>2P+E socket with shutters - complete - screw terminals</b> Supplied complete with support frame, cover plate and plate <ul style="list-style-type: none"> <li>○ White</li> <li>● Aluminium</li> <li>● Black</li> </ul>
10	7 212 33				
10	7 213 33				
10	7 214 33				
10	7 211 19	<b>2P socket with shutters - screw terminals</b> <ul style="list-style-type: none"> <li>○ White</li> <li>● Aluminium</li> <li>● Black</li> </ul>	10	7 211 28	<b>2 x 2P+E socket with shutters - automatic terminals</b> <ul style="list-style-type: none"> <li>○ White</li> <li>● Ivory</li> <li>● Aluminium</li> <li>● Black</li> </ul>
10	7 213 19		10	7 213 28	
10	7 214 19		10	7 214 28	
		<b>German standard socket outlets 16 A - 250 V~</b>			
10	7 211 20	<b>2P+E socket with shutters - automatic terminals</b> <ul style="list-style-type: none"> <li>○ White</li> <li>● Ivory</li> <li>● Aluminium</li> <li>● Black</li> </ul>	10	7 211 26	
10	7 212 20		10	7 212 26	
10	7 213 20		10	7 213 26	
10	7 214 20		10	7 214 26	
5	7 211 29	<b>2P+E socket outlet with USB Type-C charger</b> To be used for plugging in an appliance and charging a smartphone, tablet or other electronic device To replace a traditional 2P+E socket without changing the wiring or the existing box USB Type-C port: 1.5 A - 5.0 V - 7.5 W max. Consumption in passive mode < 0.07 W Class II SELV With shutters, automatic terminals <ul style="list-style-type: none"> <li>○ White</li> <li>● Ivory</li> <li>● Aluminium</li> <li>● Black</li> </ul>			
5	7 212 29				
5	7 213 29				
5	7 214 29				
10	7 211 27	<b>2P+E socket with shutters - IP 21 flap - automatic terminals</b> <ul style="list-style-type: none"> <li>○ White</li> <li>● Aluminium</li> <li>● Black</li> </ul>			
10	7 213 27				
10	7 214 27				
10	7 211 23	<b>2P+E socket with shutters - IP 44 flap - automatic terminals</b> <ul style="list-style-type: none"> <li>○ White</li> <li>● Ivory</li> <li>● Aluminium</li> <li>● Black</li> </ul>			
10	7 212 23				
10	7 213 23				
10	7 214 23				
10	7 211 25	<b>2P+E socket - screw terminals</b> <ul style="list-style-type: none"> <li>○ White</li> <li>● Ivory</li> <li>● Aluminium</li> <li>● Black</li> </ul>			
10	7 212 25				
10	7 213 25				
10	7 214 25				
10	7 211 24	<b>2P+E socket with shutters - screw terminals</b> <ul style="list-style-type: none"> <li>○ White</li> <li>● Aluminium</li> <li>● Black</li> </ul>			
10	7 213 24				
10	7 214 24				



7 212 30 + 7 215 81





7 213 30 + 7 215 11



7 211 34

Supplied with cover plates and metal support frames  
 To be equipped with plates  
 Fixing with claws (supplied) or screws  
 Flow pack packaging: robust protection to ensure optimum operation

Pack	Cat.Nos	USB charging sockets
5	7 211 30	<b>Double USB Type-A + Type-C charging socket</b> USB Type-C: 5 V, 3 A, 15 W USB Type-A: 5 V, 2.4 A, 12 W For smartphones and fast charging tablet PC Conform to IEC 62680-1-3 Certified USB-IF Surge protection > 1 kV Consumption in passive mode < 0.07 W Power supply AC/DC efficiency at highest level (VI) Screw terminals Class II ELV  <ul style="list-style-type: none"> <li>○ White</li> <li>● Ivory</li> <li>● Aluminium</li> <li>● Black</li> </ul>
5	7 212 30	
5	7 213 30	
5	7 214 30	
5	7 211 31	<b>Double Type-C + Type-C charging socket</b> 5 V, 3 A, 15 W For smartphones and fast charging tablet PC Conform to IEC 62680-1-3 Certified USB-IF Surge protection > 1 kV Consumption in passive mode < 0.07 W Power supply AC/DC efficiency at highest level (VI) Screw terminals Class II ELV  <ul style="list-style-type: none"> <li>○ White</li> <li>● Ivory</li> <li>● Aluminium</li> <li>● Black</li> </ul>
5	7 212 31	
5	7 213 31	
5	7 214 31	

1	7 211 34	<b>Wireless charger + USB Type-A socket</b> Supplied with white cover plate 1000 mA wireless charger with 1 USB socket 2.4 A, 12 W To be installed in flush-mounting boxes, surface mounting boxes, etc. Power supply stand-by mode consumption < 0.07 W Equipped with 2 induction antennas to ensure fast, intuitive smartphone charging Recognition area: 50 x 80 mm 10° inclined plate with non-slip coating to secure the terminal during charging ○ White 
---	----------	---

### Wireless charger

Charging without cord for smartphones equipped with induction receiver (Qi).

Wireless charger: 5W, average charging time: < 2h45.

USB connector Type A 2,4 A 12W for an optimal charge. Allows to charge quickly a second device (tablet, powerbank,...).

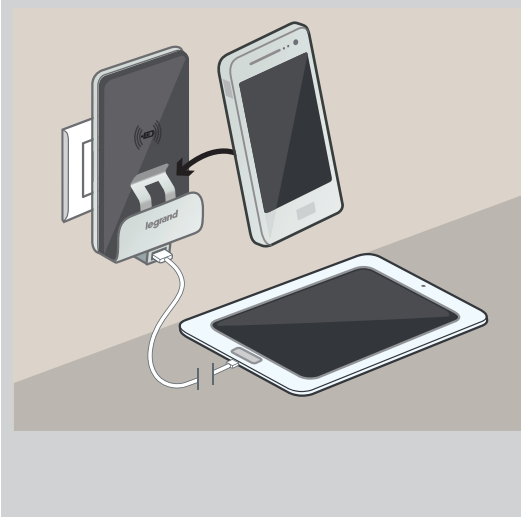

# Suno™

## TV sockets



7 211 70 + 7 215 01



7 213 67 + 7 215 11



7 214 64 + 7 215 21



7 212 62 + 7 215 81

Supplied with cover plates and metal support frames  
To be equipped with plates  
Fixing with claws (supplied) or screws  
Flow pack packaging: robust protection to ensure optimum operation

Pack	Cat.Nos	Star architecture TV sockets
10	7 211 70	<p>Star cabling (1 socket = 1 cable to antenna) ensures an HD quality level of distribution of standard TV For distribution of TV &amp; radio signals All operators (DVBT, satellite, Cablecast) Comply with EN 50083-4 and EN 50083-2 European Directives HDTV compatible: low attenuation (&lt; 1.5 dB) LTE ready, shielded socket to protect against interference from mobile phone network 3G &amp; 4G signals TV male connector (Ø9.5 mm) R female connector (Ø9.5 mm) SAT "F" type connector Recommended coaxial cable: 17/19 VATC Visual checking of the connection</p> <p><b>TV-R-SAT-SAT socket - 2 cables</b> Low attenuation: 1.5 dB TV: 5-68/120-862 MHz R: 87.5-108 MHz SAT: 950-2400 MHz</p> <p>○ White ● Aluminium ● Black</p> <p><b>TV-R-SAT socket</b> Low attenuation: 1.5 dB TV: 5-68/120-862 MHz R: 87.5-108 MHz SAT: 950-2400 MHz</p> <p>○ White ● Aluminium ● Black</p> <p><b>TV-SAT socket - 2 cables</b> Low attenuation: 1.5 dB TV: 5-68/120-862 MHz SAT: 950-2400 MHz</p> <p>○ White ● Ivory ● Aluminium ● Black</p> <p><b>Male TV socket</b> Low attenuation: 1.5 dB TV: 0-2400 MHz</p> <p>○ White ● Ivory ● Aluminium ● Black</p> <p><b>"F" type TV or SAT socket</b> Low attenuation: 1.5 dB TV: 0-2400 MHz</p> <p>○ White ● Ivory ● Aluminium ● Black</p> <p><b>"F" type TV or SAT socket + RJ 45 socket Cat. 6 UTP</b> Low attenuation: 1.5 dB TV: 0-2400 MHz</p> <p>○ White ● Ivory ● Aluminium ● Black</p>
10	7 213 70	
10	7 214 70	
10	7 211 67	<p>○ White ● Aluminium ● Black</p>
10	7 213 67	
10	7 214 67	
10	7 211 71	<p>○ White ● Ivory ● Aluminium ● Black</p>
10	7 212 71	
10	7 213 71	
10	7 214 71	
10	7 211 64	<p>○ White ● Ivory ● Aluminium ● Black</p>
10	7 212 64	
10	7 213 64	
10	7 214 64	
10	7 211 63	<p>○ White ● Ivory ● Aluminium ● Black</p>
10	7 212 63	
10	7 213 63	
10	7 214 63	
5	7 211 62	<p>○ White ● Ivory ● Aluminium ● Black</p>
5	7 212 62	
5	7 213 62	
5	7 214 62	

Pack	Cat.Nos	Star architecture TV sockets (continued)
5	7 211 73	<p><b>Double "F" type TV or SAT socket</b> Low attenuation: 1.5 dB TV: 0-2400 MHz</p> <p>○ White</p>
10	7 211 68	<p><b>Passthrough sockets</b> Installation for maintenance purposes Amplifier and line balancing are recommended TV male connector (Ø9.5 mm) R female connector (Ø9.5 mm) SAT "F" type connector Recommended coaxial cable: 17/19 VATC Visual checking of the connection</p> <p><b>TV-R-SAT socket</b> Attenuation: 14 dB TV: 5-68/120-862 MHz R: 87.5-108 MHz SAT: 950-2400 MHz</p> <p>○ White ● Aluminium ● Black</p> <p><b>Male TV socket</b> Attenuation: 14 dB TV: 0-862 MHz</p> <p>○ White ● Ivory ● Aluminium ● Black</p>
10	7 213 68	
10	7 214 68	
10	7 211 65	<p><b>Terminal sockets</b> Installation for maintenance purposes Amplifier and line balancing are recommended TV male connector (Ø9.5 mm) R female connector (Ø9.5 mm) SAT "F" type connector Recommended coaxial cable: 17/19 VATC Visual checking of the connection 1 input with 1 resistance cap socket</p> <p><b>TV-R-SAT socket</b> Attenuation: 10 dB TV: 5-68/120-862 MHz R: 87.5-108 MHz SAT: 950-2400 MHz</p> <p>○ White ● Aluminium ● Black</p> <p><b>Male TV socket</b> Attenuation: 14 dB TV: 0-862 MHz</p> <p>○ White ● Ivory ● Aluminium ● Black</p>
10	7 212 65	
10	7 213 65	
10	7 214 65	
10	7 211 69	<p>○ White ● Aluminium ● Black</p>
10	7 213 69	
10	7 214 69	
10	7 211 66	<p><b>TV-R-SAT socket cover 30 mm</b> To be used with TV socket specialist competitors' mechanisms</p> <p>○ White ● Aluminium ● Black</p>
10	7 212 66	
10	7 213 66	
10	7 214 66	
5	7 211 74	<p>○ White ● Aluminium ● Black</p>
5	7 213 74	
5	7 214 74	



7 212 52 + 7 215 81



7 214 52 + 7 215 21



7 211 47 + 7 215 01

Supplied with cover plates and metal support frames  
 To be equipped with plates  
 Fixing with claws (supplied) or screws  
 Flow pack packaging: robust protection to ensure optimum operation

Pack	Cat.Nos	Data sockets - Cat. 6A
		With LCS <sup>2</sup> connector with fast connection thanks to integrated crimping Take AWG 22 single-core cables up to AWG 26 and AWG multicore cables Contacts marked with dual colour code and wiring schemes 568 A and 568 B Conform to standards ISO/IEC 11801 Ed. 2.0, amendment 2, EN 50173-1 and TIA/EIA 568 C2
5	7 211 54	<b>RJ 45 socket Cat. 6A UTP</b> ○ White ● Ivory ● Aluminium ● Black
5	7 212 54	
5	7 213 54	
5	7 214 54	
5	7 211 58	<b>RJ 45 socket Cat. 6A STP</b> ○ White ● Aluminium ● Black
5	7 213 58	
5	7 214 58	
5	7 211 55	<b>Double RJ 45 socket Cat. 6A UTP</b> ○ White ● Ivory ● Aluminium ● Black
5	7 212 55	
5	7 213 55	
5	7 214 55	
5	7 211 59	<b>Double RJ 45 socket Cat. 6A STP</b> ○ White ● Aluminium ● Black
5	7 213 59	
5	7 214 59	
		<b>Data sockets - Cat. 6</b>
		With LCS <sup>2</sup> connector with fast connection thanks to integrated crimping Take AWG 22 single-core cables up to AWG 26 and AWG multicore cables Contacts marked with dual colour code and wiring schemes 568 A and 568 B Conform to standards ISO/IEC 11801 Ed. 2.0, amendment 2, EN 50173-1 and TIA/EIA 568 C2
10	7 211 52	<b>RJ 45 socket Cat. 6 UTP</b> ○ White ● Ivory ● Aluminium ● Black
10	7 212 52	
10	7 213 52	
10	7 214 52	
5	7 211 56	<b>RJ 45 socket Cat. 6 STP</b> ○ White ● Aluminium ● Black
5	7 213 56	
5	7 214 56	
5	7 211 53	<b>Double RJ 45 socket Cat. 6 UTP</b> ○ White ● Ivory ● Aluminium ● Black
5	7 212 53	
5	7 213 53	
5	7 214 53	
5	7 211 57	<b>Double RJ 45 socket Cat. 6 STP</b> ○ White ● Aluminium ● Black
5	7 213 57	
5	7 214 57	

Pack	Cat.Nos	Data sockets - Cat. 5e
		With LCS <sup>2</sup> connector with fast connection thanks to integrated crimping Take AWG 22 single-core cables up to AWG 26 and AWG multicore cables Contacts marked with dual colour code and wiring schemes 568 A and 568 B Conform to standards ISO/IEC 11801 Ed. 2.0, amendment 2, EN 50173-1 and TIA/EIA 568 C2
10	7 211 50	<b>RJ 45 socket Cat. 5e UTP</b> ○ White ● Aluminium ● Black
10	7 213 50	
10	7 214 50	
5	7 211 51	<b>Double RJ 45 socket Cat. 5e UTP</b> ○ White ● Aluminium ● Black
5	7 213 51	
5	7 214 51	
		<b>SC/APC single-mode fibre optic socket</b>
5	7 211 47	○ White ● Aluminium ● Black
5	7 213 47	
5	7 214 47	
		<b>Telephone sockets</b>
		<b>RJ 11 telephone socket</b> Equipped with modular jack connector with 1/4 turn terminal for fast connection Tap-off possible
5	7 211 61	○ White ● Ivory ● Aluminium ● Black
5	7 212 61	
5	7 213 61	
5	7 214 61	
5	7 211 60	<b>RJ 11 telephone socket + RJ 45 socket Cat. 6 UTP</b> ○ White ● Aluminium ● Black
5	7 213 60	
5	7 214 60	
		<b>Double Keystone adaptor</b>
5	7 211 45	○ White ● Ivory ● Aluminium ● Black
5	7 212 45	
5	7 213 45	
5	7 214 45	
		<b>Double Systemax adaptor</b>
5	7 211 46	○ White ● Aluminium ● Black
5	7 213 46	
5	7 214 46	



# Suno™

## audio/video and loudspeaker sockets



7 213 49 + 7 215 11





7 211 43 + 7 215 01

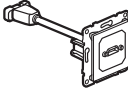

7 211 42 + 7 215 01

Supplied with cover plates and metal support frames  
To be equipped with plates  
Fixing with claws (supplied) or screws  
Flow pack packaging: robust protection to ensure optimum operation

Pack	Cat.Nos	HDMI socket
1	7 211 49	Used to transmit high-definition digital audio/video streams between a source (computer, HD-DVD drive) and a compatible receiver (TV, video projector) Screw-type HDMI 1.4 sockets Equipped with cord, length 15 cm  <ul style="list-style-type: none"> <li>○ White</li> <li>● Ivory</li> <li>● Aluminium</li> <li>● Black</li> </ul>
1	7 212 49	
1	7 213 49	
1	7 214 49	
5	7 211 92	<b>Loudspeaker socket</b> 4 mm <sup>2</sup> terminals  <ul style="list-style-type: none"> <li>○ White</li> <li>● Ivory</li> <li>● Aluminium</li> <li>● Black</li> </ul>
5	7 212 92	
5	7 213 92	
5	7 214 92	



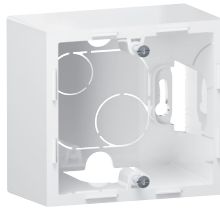

# Suno™

## accessories



7 211 94

Flow pack packaging: robust protection to ensure optimum operation

Pack	Cat.Nos	Blanking plate
5	7 211 43	Equipped with Mosaic adaptor  <ul style="list-style-type: none"> <li>○ White</li> <li>● Ivory</li> <li>● Aluminium</li> <li>● Black</li> </ul>
5	7 212 43	
5	7 213 43	
5	7 214 43	
5	7 211 42	<b>IP 21 cable outlet</b> Maximum cable diameter: 12 mm With cable grip  <ul style="list-style-type: none"> <li>○ White</li> <li>● Ivory</li> <li>● Aluminium</li> <li>● Black</li> </ul>
5	7 212 42	
5	7 213 42	
5	7 214 42	
5	7 211 94	<b>Surface-mounting boxes</b> <b>1-gang</b>  <ul style="list-style-type: none"> <li>○ White</li> <li>● Ivory</li> <li>● Aluminium</li> <li>● Black</li> </ul>
5	7 212 94	
5	7 213 94	
5	7 214 94	
5	7 211 95	<b>2-gang</b>  <ul style="list-style-type: none"> <li>○ White</li> <li>● Ivory</li> <li>● Aluminium</li> <li>● Black</li> </ul>
5	7 212 95	
5	7 213 95	
5	7 214 95	

All plates can be mounted horizontally or vertically

FINISH	PLATES					
	1-gang	1-gang - IP 44	2-gang	3-gang	4-gang	5-gang
<b>White</b>	7 215 01	-	7 215 02	7 215 03	7 215 04	7 215 05
<b>White IP 44</b>	-	7 211 44 <sup>(1)</sup>	-	-	-	-
<b>Aluminium</b>	7 215 11	-	7 215 12	7 215 13	7 215 14	7 215 15
<b>Aluminium IP 44</b>	-	7 213 44 <sup>(1)</sup>	-	-	-	-
<b>Black</b>	7 215 21	-	7 215 22	7 215 23	7 215 24	7 215 25
<b>Black IP 44</b>	-	7 214 44 <sup>(1)</sup>	-	-	-	-
<b>Dune</b>	7 215 31	-	7 215 32	7 215 33	7 215 34	7 215 35
<b>Feather</b>	7 215 41	-	7 215 42	7 215 43	7 215 44	7 215 45
<b>Dark Grey</b>	7 215 51	-	7 215 52	7 215 53	7 215 54	7 215 55
<b>Brushed Aluminium</b>	7 215 61	-	7 215 62	7 215 63	7 215 64	7 215 65
<b>Patterned Black</b>	7 215 71	-	7 215 72	7 215 73	7 215 74	7 215 75
<b>Ivory</b>	7 215 81	-	7 215 82	7 215 83	7 215 84	7 215 85
<b>Ivory IP 44</b>	-	7 212 44 <sup>(1)</sup>	-	-	-	-
<b>Champagne</b>	7 215 91	-	7 215 92	7 215 93	7 215 94	7 215 95
<b>Titanium</b>	7 216 01	-	7 216 02	7 216 03	7 216 04	7 216 05

1: Compatible with all Suno™ mechanisms - IP 44 / IK 04 - UV-resistant

## Connected home

### connected starter pack

Must be ordered for any connected installation

#### Step 1: Starter pack for a connected home



7 221 70  
+ 2 x 7 215 01

To be used to control your home remotely (lighting, roller shutters and electrical appliances) using a smartphone via the Home + Control app and/or voice control (via a voice assistant)  
Must be ordered for any connected installation  
The connected extension pack or individual connected products can be added to the starter pack  
2.4 GHz Wi-Fi connection required

Pack	Cat.Nos	Connected starter pack
		Used to create the radio network and the Wi-Fi connection Composition: - 1 flush-mounted Zigbee/Wi-Fi gateway Mechanisms supplied with cover plates, to be equipped with plates Allows the connection of the installation to the Wi-Fi network and enables control through the Home + Control app and voice assistants (Google Assistant, Amazon Alexa, Apple Siri) <sup>1)</sup> Can be installed in place of an existing product Suitable for flush-mounting box min. depth 35 mm - 1 Home/Away wireless master switch with preset life scenes Supplied with cover plate To be equipped with plates Used to create the radio network and to control life scenes Life scenes can be customised in the Home + Control app Supplied with CR2032 3 V long-life battery for power supply and 2 removable stickers for fixing the control unit on any substrate LED function for low battery indication
1	7 221 70	<ul style="list-style-type: none"> <li>○ White</li> <li>● Ivory</li> <li>● Aluminium</li> <li>● Black</li> </ul>
1	7 222 70	
1	7 223 70	
1	7 224 70	

1: Availability of voice assistants to be checked in your country

## Connected home

### connected products

Zigbee certified products

#### Step 2: Connected products



7 223 72 + 7 215 11



7 224 82 + 7 215 21

To be used to complete your connected installation, require prior installation of a starter pack for connected installations

Pack	Cat.Nos	Connected light switches without neutral (with dimmer option)
		For local or remote ON/OFF or dimming control of lighting. Can be controlled by one or more wireless light switches. Dimmer mode and locator/indicator functions can be activated from the Home + Control App. Compatible with all loads: - Dimmable LEDs: 50 W - Halogen with transformer: 300 VA - Fluorescent tube: 300 VA - Halogen 230 V and incandescent: 300 W Supplied with a bleeder Memory level function Can be installed in place of an existing switch in a flush-mounting box depth 40 mm. Screw or claw fixing, supplied with claws and site protection covers. To be equipped with plates 5-300 W wired switches without neutral 230 V~
		<ul style="list-style-type: none"> <li>○ White</li> <li>● Ivory</li> <li>● Aluminium</li> <li>● Black</li> </ul>
		<b>2023</b>
1	7 221 72	
1	7 222 72	
1	7 223 72	
1	7 224 72	
Pack	Cat.Nos	Connected two-gang light switches with neutral
		Enables both local and remote control of 2 lighting circuits Can be combined with one or more wireless controls Two-gang wired switch 2 x 250 W with neutral 230 V~ Compatible with all loads Locator LED can be activated from the Home + Control app Can be installed in place of an existing two-gang switch in a 40 mm deep flush-mounting box Screw or claw mounting, supplied with site protection 2x250 W wired switches with neutral 230 V~
		<ul style="list-style-type: none"> <li>○ White</li> <li>● Ivory</li> <li>● Aluminium</li> <li>● Black</li> </ul>
		<b>2023</b>
1	7 221 82	
1	7 222 82	
1	7 223 82	
1	7 224 82	

### Step 2: Connected products





7 221 71 + 7 215 01





0 648 88

To be used to complete your connected installation, require prior installation of a starter pack for connected installations

Pack	Cat.Nos	<b>Connected dimmer</b>
		150 W with neutral. For local or remote ON/OFF or dimming control of lighting. Can be controlled by one or more wireless light switches or mechanical push-buttons without neon. Dimmer mode and locator/indicator functions can be activated from the Home + Control app Compatible with all loads: - Dimmable LEDs: 150 W - Halogen with transformer: 150 VA - Fluorescent tube: 150 VA - Halogen 230 V and incandescent: 150 W Supplied with a bleeder Memory level function Can be installed in place of an existing switch in a flush-mounting box depth 40 mm. Screw or claw fixing, supplied with claws and site protection covers. To be equipped with plates
1	7 221 71	 <ul style="list-style-type: none"> <li>○ White</li> <li>● Ivory</li> <li>● Aluminium</li> <li>● Black</li> </ul>
1	7 222 71	
1	7 223 71	
1	7 224 71	

Pack	Cat.Nos	<b>Wireless light switch - 2-gang</b>
		To be used to add two extra lighting controls Easy pairing by tapping the wired product or by using the Home + Control app Supplied with CR2032 3 V battery for power supply and removable stickers for fixing the control unit on any substrate LED function for low battery indication To be equipped with plates
1	7 221 74	 <ul style="list-style-type: none"> <li>○ White</li> <li>● Ivory</li> <li>● Aluminium</li> <li>● Black</li> </ul>
1	7 222 74	
1	7 223 74	
1	7 224 74	

Pack	Cat.Nos	<b>Connected lighting micromodule</b>
		To be used to provide connected lighting 300 W, with neutral Can be controlled by one or more wireless light switches - paired by tapping the wireless control on the micromodule Auxiliary input for use of a push-button For installation near the light source
1	0 648 88	

Pack	Cat.Nos	<b>Wireless light switch - 1-gang</b>
		To be used to add an extra lighting control Easy pairing by tapping the wired product or by using the Home + Control app Supplied with CR2032 3 V battery for power supply and removable stickers for fixing the control unit on any substrate LED function for low battery indication To be equipped with plates
1	7 221 73	 <ul style="list-style-type: none"> <li>○ White</li> <li>● Ivory</li> <li>● Aluminium</li> <li>● Black</li> </ul>
1	7 222 73	
1	7 223 73	
1	7 224 73	

# Connected home

connected products (continued)

Zigbee certified products

## Step 2: Connected products



7 221 80 + 7 215 01



7 224 79 + 7 215 21

To be used to complete your connected installation, require prior installation of a starter pack for connected installations

Pack	Cat.Nos	Connected power outlet
		To be used to control electrical appliances remotely Can be paired with one or more wireless light switches to create a controlled socket. Secured 16 A power outlet for overload prevention. Compatible with any electrical appliance or large household appliance. Measures real-time power and monitors daily and monthly consumption, plus sends configurable notifications (fault, consumption, etc). Can be installed in place of an existing socket outlet in 1-gang box 40 mm deep, supplied with claws and site protection covers. Screw or claw fixing. Connection via automatic terminals. LED light (indicator function) turned ON when the power outlet is being used To be equipped with plates
	<b>2023</b>	<b>German standard</b>
1	7 221 80	White
1	7 222 80	Ivory
1	7 223 80	Aluminium
1	7 224 80	Black

Pack	Cat.Nos	Connected roller shutter switch
		For local and remote control of a roller shutter (not compatible with radio-controlled roller shutters) Can be paired with one or more roller shutter wireless switches 230 V~ Phase + Neutral power supply Can be installed in place of an existing roller shutter switch in a flush-mounting box 40 mm deep LED light (locator function) can be activated via the Home + Control app Screw or claw fixing, supplied with claws and site protection covers To be equipped with plates
	<b>2023</b>	
1	7 221 78	White
1	7 222 78	Ivory
1	7 223 78	Aluminium
1	7 224 78	Black

Pack	Cat.Nos	Roller shutter wireless switch
		To be used to control up to 20 wired roller shutter switches Pair by tapping on the selected roller shutter switch(es) Supplied with CR2032 3 V battery for power supply and removable stickers for fixing the control unit on any substrate LED function for low battery indication To be equipped with plates
	<b>2023</b>	
1	7 221 79	White
1	7 222 79	Ivory
1	7 223 79	Aluminium
1	7 224 79	Black

### Step 2: Connected products



7 223 76 + 7 215 11



7 221 77 + 7 215 01



7 224 75 + 7 215 21



0 648 79

To be used to complete your connected installation, require prior installation of a starter pack for connected installations

Pack	Cat.Nos	Home/Away wireless master switch
		To be used to add an extra Home/Away wireless master switch Works the same way as the Home/Away wireless master switch included in the starter pack Home/Away life scenes can be customised via the Home + Control app Supplied with CR2032 3 V battery for power supply and removable stickers for fixing the control unit on any substrate LED function for low battery indication To be equipped with plates
	<b>2023</b>	
1	7 221 76	○ White
1	7 222 76	○ Ivory
1	7 223 76	● Aluminium
1	7 224 76	● Black

Pack	Cat.Nos	Wake up/Sleep wireless switch
		To be used to add 2 extra scenes to a connected installation Preset Wake up/Sleep life scenes: can be customised via the Home + Control app Supplied with CR2032 3 V battery for power supply and removable stickers for fixing the control unit on any substrate. LED function for low battery indication To be equipped with plates
	<b>2023</b>	
1	7 221 77	○ White
1	7 222 77	○ Ivory
1	7 223 77	● Aluminium
1	7 224 77	● Black

Pack	Cat.Nos	4-scene wireless switch
		To be used to add 4 customised scenes to a connected installation Scenes can be customised via the Home + Control app Possible to assign personalised names and to associate icons with scenes in the Home + Control app Supplied with CR2032 3 V battery for power supply and removable stickers for fixing the control unit on any substrate. LED function for low battery indication To be equipped with plates
	<b>2023</b>	
1	7 221 75	○ White
1	7 222 75	○ Ivory
1	7 223 75	● Aluminium
1	7 224 75	● Black

Pack	Cat.Nos	Connected cable outlet
		To be used to remotely control electrical devices Wiring compatible with the pilot wire 6-order pilot wire control (on compatible heating systems) Can be controlled via a wireless switch 3000 W max. (protected against overloads) Functions: - ON/OFF - measurement of real-time power and monitoring of the daily and monthly consumption (with configurable notification system: fault, consumption, etc) LED light (indicator function) turned ON when the cable outlet is being used To be equipped with plates Multi-gang fixing not possible
	<b>2023</b>	
1	0 648 79	○ White
1	0 648 63	○ Ivory
1	0 648 98	● Aluminium
1	0 648 47	● Black



**FOLLOW US  
ON**

- @ legrand.com
-  youtube.com/user/legrand
-  facebook.com/Legrand
-  twitter.com/Legrand
-  pinterest.com/legrandgroup
-  instagram.com/legrandnews



**Lithuania**

Perkunkiemio st. 3,  
LT-12127, Vilnius

**Latvia**

Dārziema iela 60,  
LV-1073, Rīga

**Estonia**

Teemeistri tn. 2,  
EE-10916, Tallinn