

Classia Dimmer

RW4402 - RG4402
RW4411 - RG4411

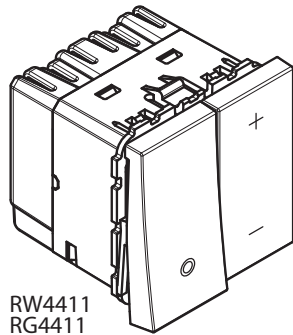

RW4411
RG4411

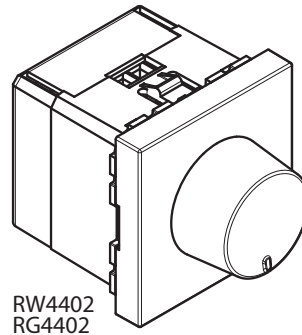

RW4402
RG4402

Use

The dimmer can increase or reduce the light to create the right atmosphere.

Range

Designation	Item
Universal Dimmer	<input type="checkbox"/> RW4411
	<input checked="" type="checkbox"/> RG4411
Rotary Dimmer	<input type="checkbox"/> RW4402
	<input checked="" type="checkbox"/> RG4402

Color code:

White colour Black colour

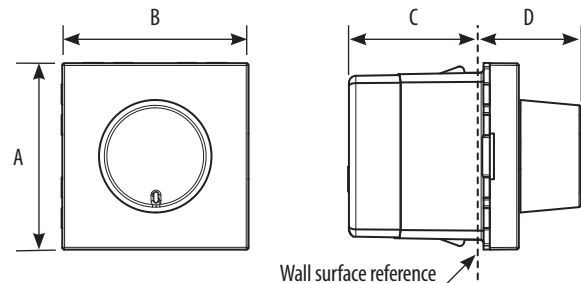

	A	B	C	D
..4402	45.1	45	31.2	24.8

Connection

Terminal type: screw clamp
Terminal capacity: 2 x 2,5 mm² max
Stripping length: 8 mm
Compatible with flexible or rigid cables

Overall dimensions (mm)

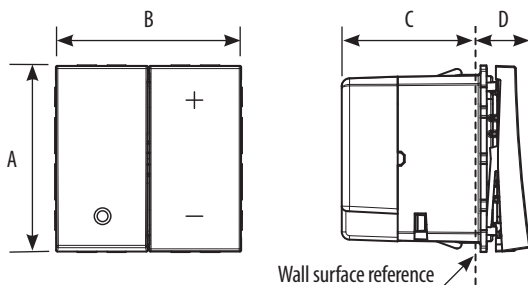







	A	B	C	D
..4411	45.1	45	32.2	13.2

Technical characteristics







- **Protection index**
(considering a complete installation, including cover plate)
Penetration by solid bodies/liquid: IP40
- **Mechanical characteristics**
Impact test: IK 04
- **Material characteristics**
Case and Key cover: PC (Polycarbonate)
Halogen free.
UV resistant.
- Self-extinguishing:
850° C / 30 s for insulating parts holding live parts in place
650° C / 30 s for other parts made of insulating materials
- **Electrical characteristics**
Voltage: 100 – 240 V a.c.
Frequency: 50/60 Hz
Consumption on standby: 0.1 W

Table of admissible loads for ..4411

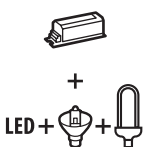
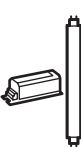
		R		L
				^(*)  + 
				
240 V	Max.	400 W	400 W	400 VA
	Min.	3 W	3 W	3 VA
100 V	Max.	200 W	200 W	200 VA
	Min.	3 W	3 W	3 VA







Do not mix different load types on the same product

(*) Use only with transformers designed to function with electronic switches.

		C/L			
				Dimmable 	Dimmable LED 
					
240 V	Max.	400 VA	200 VA	75 VA or 10 lamps max.	75 VA or 10 lamps max.
	Min.	3 VA	3 VA	3 VA	3 VA
100 V	Max.	200 VA	100 VA	37 VA or 10 lamps max.	37 VA or 10 lamps max.
	Min.	3 VA	3 VA	3 VA	3 VA

Do not mix different load types on the same product

Table of admissible loads for ..4402

		R		L
				^(*)  + 
				
230 V	Max.	400 W	400 W	400 VA
	Min.	40 W	40 W	40 VA
110 V	Max.	200 W	200 W	200 VA
	Min.	20 W	20 W	20 VA

Do not mix different load types on the same product

(*) Use only with transformers designed to function with electronic switches.

- Climatic characteristics

Storage temperature: - 10° C to + 70° C

Use temperature: - 5° C to + 35° C

Cleaning

Clean the surface with a cloth.

Do not use acetone, tar-removing cleaning agents or trichloroethylene.

Caution: Always test before using special cleaning products.

Standards and approvals

Compliance with standards IEC/EN 60669-2-1.

Refer to e.catalogue.