

Floor receptacles to equip

Cat. No(s): 0 897 00/01/02/10/11/12/50/51/52

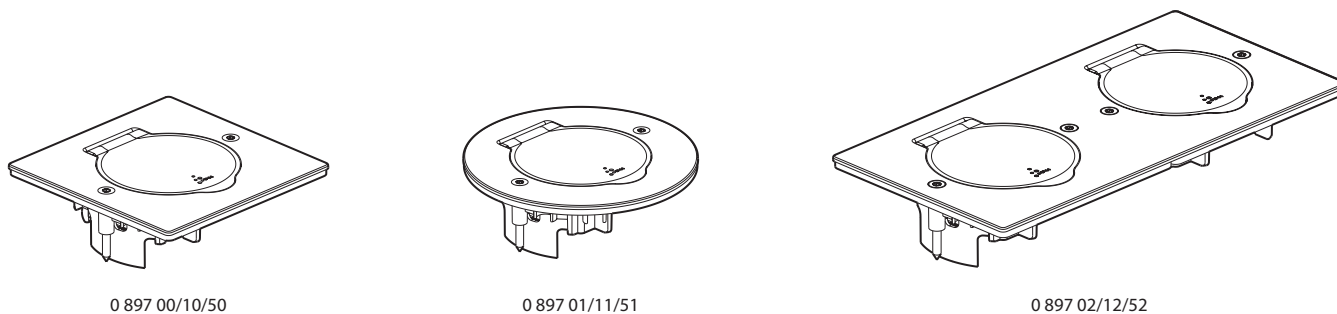

1. USE

Range of square, rectangular and round floor receptacles, supplied empty.
 To be fitted with Mosaic or Arteor 45 x 45 maxi voltage or low voltage functions (excepted British, American, South-African, Multistandard, Australian and Chinese standards).

2. RANGE

Description	Brushed stainless steel	Brushed gold	Brushed brown steel
Square floor receptacle	0 897 00	0 897 10	0 897 50
Round floor receptacle	0 897 01	0 897 11	0 897 51
Rectangular floor receptacle	0 897 02	0 897 12	0 897 52

3. DIMENSIONS (mm)

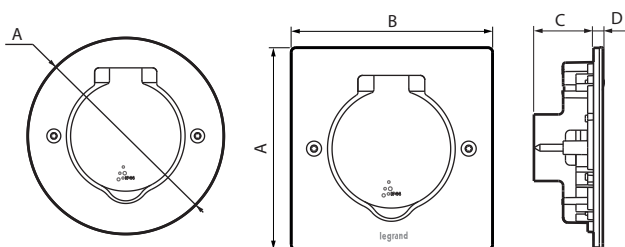

Cat. Nos	A	B	C	D
0 897 00/10/50	86	86	28	2
0 897 01/11/51	90	-	28	2
0 897 02/12/52	86	172	28	2

4. OPERATION

Floor box 0 819 88

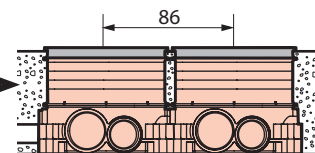
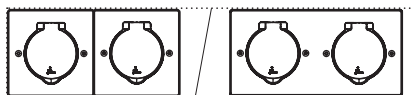
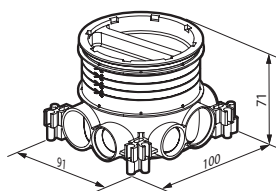

Batibox box 0 801 88

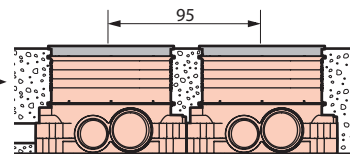
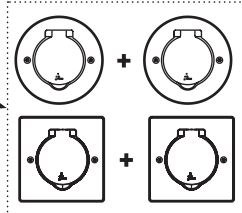
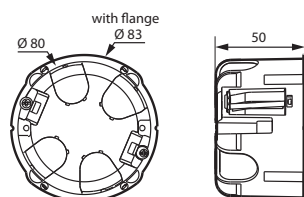

5. RECOMMENDATIONS

- For installing indoors or outdoors (in a protected unit).
- Essential requirement: Install the «small plugs» behind the plate if installing the socket using box Cat. No. 0 801 88.
- White indicator: Illuminated accessibility markings.

6. TECHNICAL CHARACTERISTICS

■ 6.1 Mechanical characteristics

Protection against solid/bodies and liquids: IP 44 } cover closed
 Protection against impacts: IK 08
 Cover can open 180°

■ 6.2 Material characteristics

Finishes: Brushed stainless steel, brushed gold, brushed brown steel
 Material: Zamak + surface treatment
 Fixing screws: stainless steel Torx T10

Self-extinguishing:

850° C / 30 s for insulating parts holding live parts in place
 650° C / 30 s for other parts made of insulating materials

■ 6.3 Climatic characteristics

Storage temperature: - 10° C to + 70° C
 Use temperature: - 5° C to + 35° C

7. CLEANING

Do not use detergents.

8. ACCESSORIES

Cat. No 0 819 88: Single multimaterial floor box for concrete floors and engineered floors, depth of 50 to 80 mm

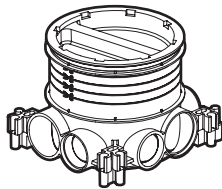

Cat. No 0 801 88: Multimaterial Batibox box Ø 80 mm

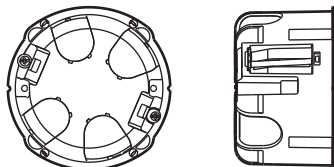

Cat. No 0 897 19: Indicator light for socket floor - 230 V - 1mA - White

Cat. No 0 897 09: Long screws (x 10)

Cat. No 0 885 08: Hole saw Ø 79 mm